

# PRODUCT GUIDE

---

SENSORS  
 CONTROLLERS  
 MOTION DEVICES  
 PROCESS AUTOMATION  
 CONNECTORS/CABLES  
 CONTROL SWITCHES



# BC Series

## Color Mark Sensors



## Outstanding Color Matching Accuracy

### FEATURES

- Outstanding color matching accuracy
  - RGB light emitting diodes and 12-bit resolution
  - 2 detection modes (color only / color + intensity)
  - 3-step sensitivity adjustment for each mode (fine, normal, rough)
- External light interference reduction minimizes errors and allows stable detection
- Check reference color with teaching indicator
- Operation indicator (red LED), stability indicator (green LED), timer indicator (orange LED)
- Configure operation functions with external input from wiring
- W 1.24 x L 6.7 mm spot size for detection of tiny targets and color marks
- IP67 protection structure (IEC standard)

### APPLICATION

- BC series color mark sensors used for presence detection of product labels
- BC series color mark sensors used for error detection during manufacturing processes
- BC series color mark sensors used to check location of package stamping

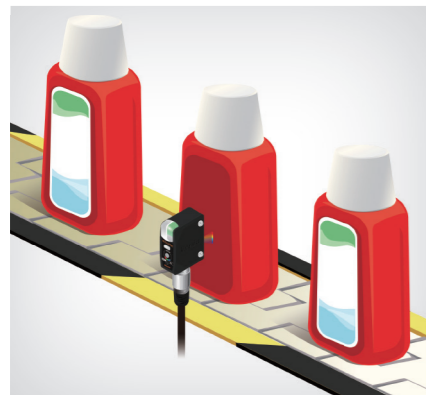

# BH Series

## M18 Front/Side Mount Photoelectric Sensors



### FEATURES

- Front mounting (M18 nut) or side mounting (M3 screws)
- Simultaneous NPN/PNP open collector output
- Sensing distance:
  - Through-beam type: 20 m
  - Retroreflective type: 4 m
  - Diffuse reflective type: 1 m, 300 mm
- Compact size: W 14 mm x H 34.5 mm x L 28 mm
- Mirror Surface Rejection (MSR) function allows stable detection of highly reflective targets (retroreflective type only)
- Sensitivity adjuster included
- Light ON / Dark ON operation mode switch
- Operation indicator (red LED) and stability indicator (green LED)
- Built-in reverse polarity protection circuit and output overcurrent (short-circuit) protection circuit
- Mutual interference prevention function (except through-beam type)
- IP67 protection structure (IEC standard)

### APPLICATION

- BH series front/side mounting photoelectric sensors used for presence detection of aluminum cans during manufacturing process.



# BTF / BTS Series

Ultra-Compact, Thin Type Photoelectric Sensors with Built-In Amplifiers CE



Remarkably Slim and Compact

### FEATURES

- |   |  |
|---|--|
| <p><b>[BTF Series]</b></p> <ul style="list-style-type: none"> <li>- Through-beam type (BTF1M): Ø2 mm</li> <li>- Diffuse reflective type (BTF30): Ø0.2 mm (at distance 10 mm)</li> <li>- BGS reflective type (BTF15): Ø0.2 mm (at distance 10 mm)</li> </ul> <p>※Detecting distance may vary by environmental factors</p> <p><b>[Common Features]</b></p> <ul style="list-style-type: none"> <li>• Stability indicator (green LED) and operation indicator (red LED)</li> <li>• Stainless steel 304 mounting brackets</li> <li>• IP67 protection structure (IEC standard)</li> </ul> | <p><b>[BTS Series]</b></p> <ul style="list-style-type: none"> <li>- Through-beam type (BTS1M): Ø2 mm</li> <li>- Retroreflective type (BTS200): Ø2 mm (at distance 100 mm)</li> <li>- Convergent reflective type (BTS15/30): Ø0.15 mm (at distance 10 mm)</li> </ul> <p>※Detecting distance may vary by environmental factors</p> |
|---|--|

### APPLICATION

- BTF series photoelectric sensors used for presence detection of semiconductor wafer enclosure transfer
- BTS series photoelectric sensors used for presence detection of clutches in automatic laser marking machines

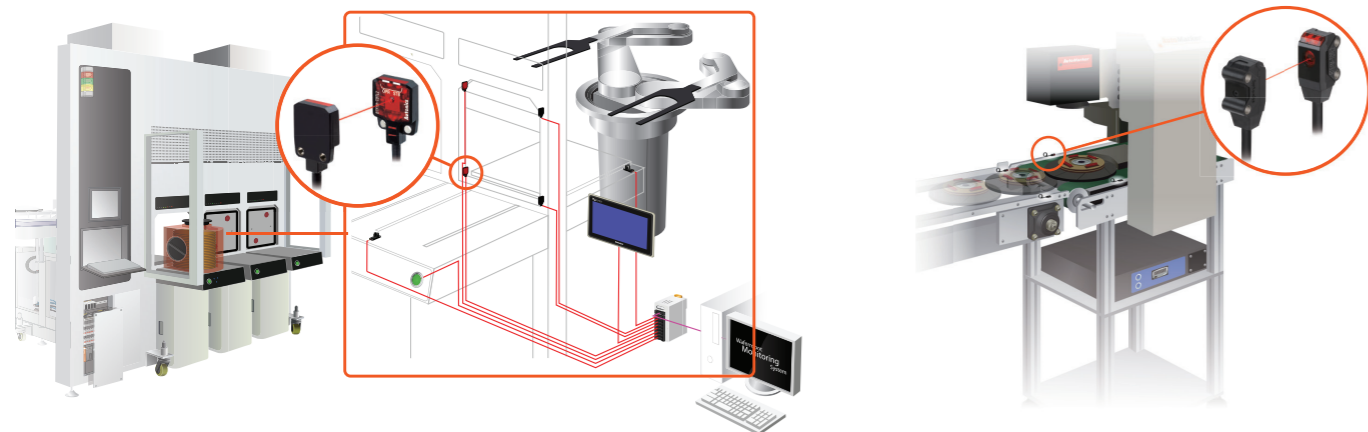

# BJ Series

Compact High Performance Photoelectric Sensors CE

### FEATURES

- Various detection type models available: (long distance, BGS reflective, transparent glass, micro spot)
- Compact size: W 10.6 × H 32 × L 20 mm
- Light ON/Dark ON operation mode switch
- Sensitivity adjuster
- Mutual interference prevention function



# BS5-P Series

Push Button Type Photomicro Sensors CE

### FEATURES

- Button switch operation ensures accurate detection regardless of material, color, or reflectivity of target objects
- Optimized for transport detection of semiconductor wafer enclosures
- Mechanical life cycle of 5 million operations
- Four operation indicators (red LED) [side: 2, top: 2]
- Stainless steel mounting brackets



# BEN Series

Universal AC/DC Photoelectric Sensors with Built-In Amplifiers CE

### FEATURES

- Universal AC/DC models (relay contact output) available
- Light ON/Dark ON operation mode switch
- Sensitivity adjuster (except through-beam types)
- Specialized, high-performance sensor IC
- Output types: relay contact (AC/DC type), NPN/PNP open collector (DC type)



# MST Series

Retroreflective Tape

### FEATURES

- Attach in settings where mirrors can be difficult to install (i.e. curved surfaces, narrow spaces, moving targets, etc.)
- Can be easily cropped to fit environmental settings
- High retroreflectivity per surface area

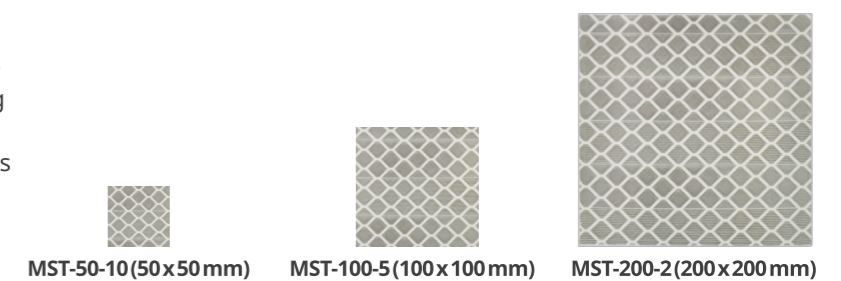

## BL Series

### Compact Photoelectric Liquid Level Sensors



#### FEATURES

- Photoelectric sensors for non-contact detection of liquid in transparent pipes
- Detects presence of liquid in transparent pipes (external diameter 6 to 13 mm, <1 mm thick)
- Compact size: W 23 x H 14 x L 13 mm
- Light ON/Dark ON operation mode switch
- Operation mode indicator (green LED) [Light ON: on, Dark ON: off]
- Operation status indicator (red LED)



※Protection bracket (sold separately)

## BR Series

### Cylindrical (Ø18 mm) Photoelectric Sensors



#### FEATURES

- Long sensing distance: 20 m (through-beam type)
- Excellent noise resistance with digital signal processing
- High-speed response time under 1 ms
- Sensitivity adjuster (except through-beam type)
- IP66 protection structure (IEC standard)



Connector Type

Cable Type

## BS5 Series

### Ultra-Compact Photomicro Sensors



#### FEATURES

- Ultra-compact size with built-in amplifier (NPN or PNP open collector)
- Various shapes available for installation flexibility (K, T, L, Y, V types)
- High-speed response frequency: 2 kHz
- Switch between Light ON and Dark ON modes using control terminal/wire
- Dust resistant build with protection window (emitter/receiver)
- Wide power supply range: 5-24 VDC
- Operation indicator (red LED)

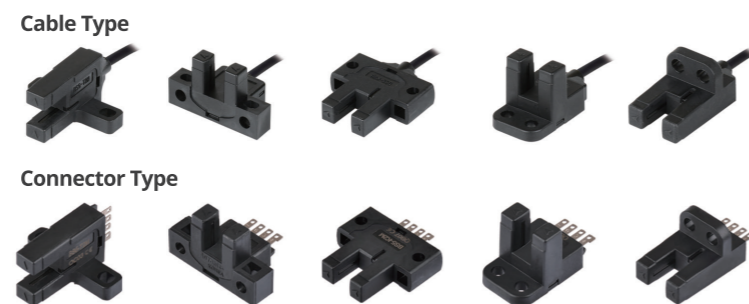

Cable Type

Connector Type

#### Photoelectric Sensors



**BPS Series**  
Compact Flat Type

**BA2M Series**  
Long Distance,  
Diffuse Reflective Type

**BYD Series**  
Compact Standard Type

**BMS Series**  
Side Sensing Type

**BX Series**  
Universal  
AC/DC Type

**BUP Series**  
U-Shaped Type

## BW/BWC/BWP/BWPK Series

### Area Sensors / Picking Sensors



#### FEATURES

##### BW Series

General Purpose Area Sensors

##### BWC Series

Cross-Beam Area Sensors

##### BWP Series

Flat Body Area Sensors  
(Plastic Body)

##### BWPK Series

Flat Body Picking Sensors

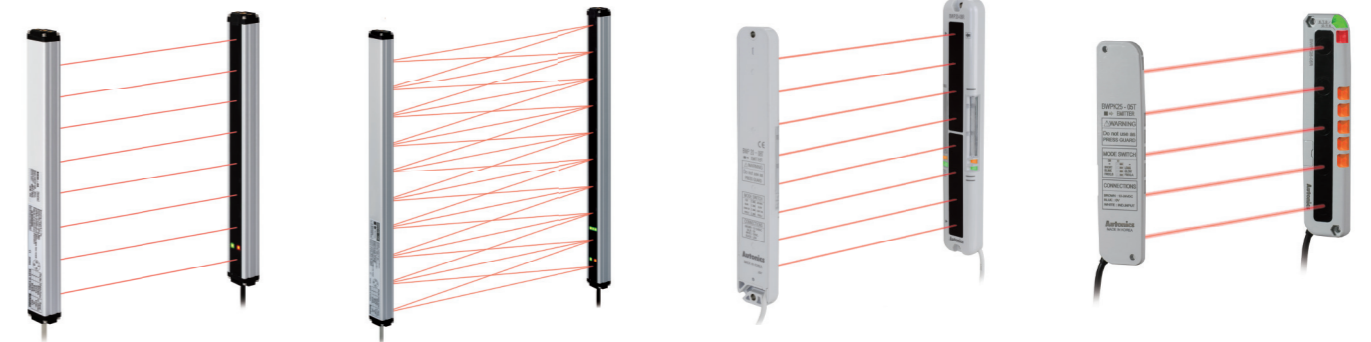

- Long sensing distance (up to 7 m)
- Economical, reliable, with diverse configurations

- 3-point cross-beam type area sensors
- Stable detection in bright environments (100,000 lx)

- Slim body (13 mm) with Fresnel lens
- High-speed response time (under 7 ms)

- Slim body (10 mm) with Fresnel lens
- Highly visible job indicators provide clear status identification

## BF5 Series

### High Speed Single/Dual Digital Display Digital Fiber Optic Amplifiers



#### FEATURES

- Available in dual and single display models
- Dual digital display for displaying PV and SV (BF5□-D)
- 5 response speeds (50 μs, 150 μs, 500 μs, 4 ms, 10 ms)
- Display range: 0-4000 (standard mode), 0-9999 (long-distance mode)
- Simple sensitivity adjustment settings
- Saturation prevention function, inverted display, mutual interference prevention, auto channel setting function

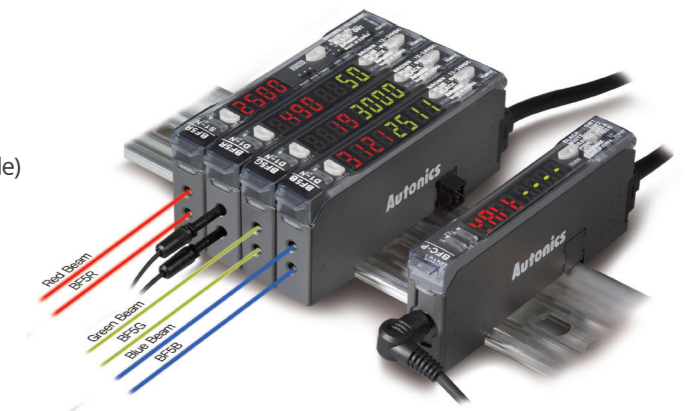

Communication Converters  
BFC Series

## FD/FT/FL/GD/GT Series

### Fiber Optic Sensor Cables

#### FEATURES

- Various cable head types (thread, cylindrical, flat, perpendicular, plastic, area detection)
- Various sensing directions (top, side, flat, L-type top, top + side)
- Various sensing modes (through-beam, diffuse reflective, convergent reflective)
- Various cable types (standard, flexible, coaxial, break-resistant, heat-resistant)
- Diverse line-up, easy installation, high performance

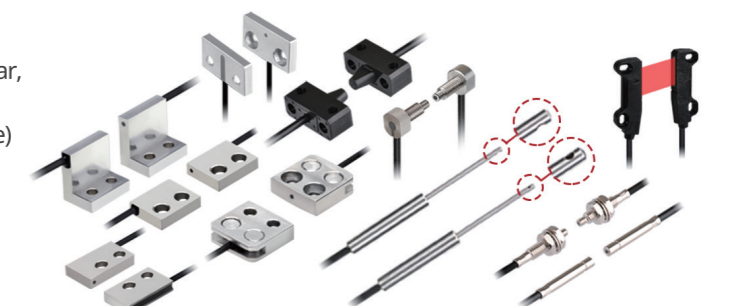

# PSQ Series

## Dual Display Digital Pressure Sensors



### FEATURES

- Dual display for simultaneous display of process value (PV) and setpoint value (SV)  
\*Secondary (SV) display: setpoint value, pressure unit, or display-OFF
- Switch between NPN and PNP open collector output via parameter configuration
- 3-color main (PV) display  
(RUN mode: green/red, parameter setting mode: orange)
- 12-segment LCD display capable of diverse alphanumeric characters
- Measurement range: -100.0 to 100.0 kPa / -100 to 1000 kPa  
(Pneumatic type: compound pressure, Fluid type: sealed gauge pressure)
- Display resolution: 0.1 kPa / 1 kPa (by model)



Pneumatic Type

Fluid Type

### APPLICATION

- PSQ series pressure sensors used for air-leak test of PET bottles



- PSQ series pressure sensors used for suction confirmation of semiconductor components

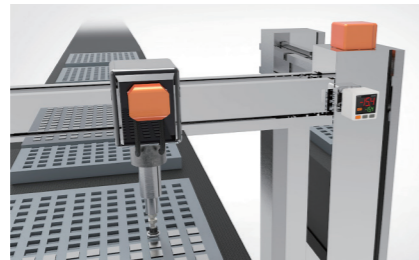

- PSQ series pressure sensors used to confirm reference pressure of pipes.



# PSAN Series

## Compact Digital Pressure Sensors



### FEATURES

- Pressure measurement of any gas, liquid or oil
- High display resolution:
  - negative, compound pressure 0.1 kPa
  - standard pressure 0.1 kPa, 1 kPa
- Auto shift function, hold function
- Independent 2-point output (N.O. / N.C. output selectable)
- Zero-point adjustment function, peak value monitoring function, chattering prevention function



Fluid Type  
(Cable Type)

Fluid Type  
(Connector Type)

Pneumatic Type  
(Connector Type)

### APPLICATION

- PSAN series pressure sensors used to measure the pressure of water sprays in a potato washing conveyor belt



# PRF(A) Series

## Full-Metal Cylindrical Inductive Proximity Sensors



PRF Series

PRFA Series

### FEATURES

- High resistance to impact and wear caused by contact with workpieces or wire brushes (sensor head/housing: stainless steel)
- Reduced risk of malfunction caused by aluminum chips
- PTFE coating prevents malfunctions caused by welding spatter (spatter-resistant models)
- Excellent noise immunity with specialized sensor IC
- Built-in surge protection circuit and overcurrent protection circuit
- 360° ring type operation indicator (red LED)
- Oil resistant cable
- IP67 protection structure (IEC standard)

### APPLICATION

- PRF series full-metal inductive sensors used to detect tray locations on food cleaning machines.

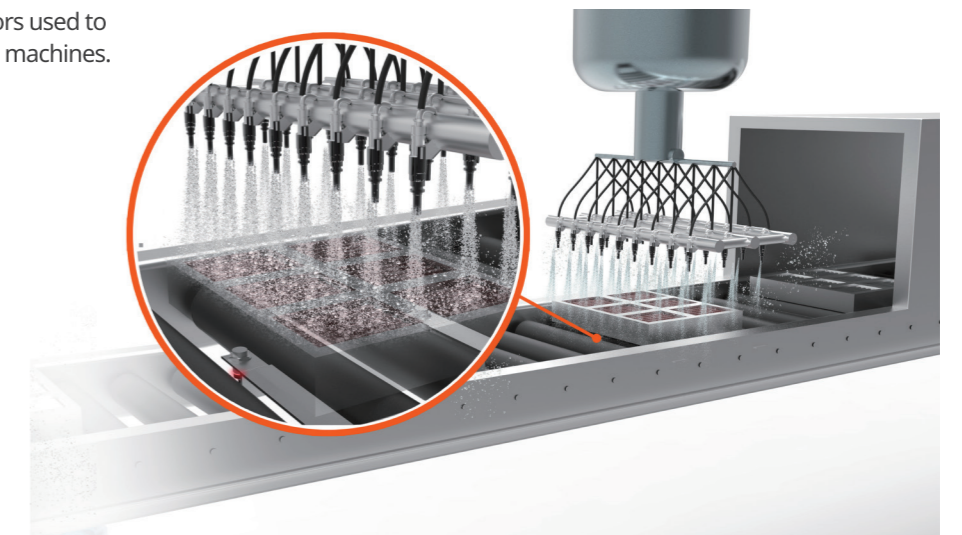

## PR Series

### Standard Cylindrical Inductive Proximity Sensors



#### FEATURES

- Excellent noise resistance with specialized sensor IC
- Built-in surge protection circuit, reverse polarity protection circuit (DC 3-wire types), and overcurrent protection circuits (DC types)
- Operation indicator (red LED)
- Durable and reliable alternative to micro switches and limit switches
- IP67 protection structure (IEC standard)



PR(T) Series Cable Type

PRCM(T) Series Connector Type

PRW(T) Series Cable Connector Type

## PRD Series

### Cylindrical Inductive Proximity Sensors With Long Sensing Distance



#### FEATURES

- Long sensing distance and excellent noise resistance with specialized sensor IC
- Simple operation, reliable performance, and high durability
- Built-in surge protection circuit, reverse polarity protection circuit, and overcurrent protection circuits
- Operation indicator (red LED)
- IP67 protection structure (IEC standard)



PRD(T) Series Cable Type

PRDCM(T) Series Connector Type

PRDW(T) Series Cable Connector Type

## PRA Series

### Cylindrical Spatter-Resistant Inductive Proximity Sensors



#### FEATURES

- Coated with teflon for high heat resistance (prevent malfunction from welding spatter)
- Excellent noise resistance with specialized sensor IC
- Built-in surge protection circuit
- Built-in overcurrent protection circuit (DC 2-wire, DC 3-wire types)
- Built-in reverse polarity protection circuit (DC 3-wire types)



PRA(T) Series Cable Type

PRACM(T) Series Connector Type

PRAW(T) Series Cable Connector Type

## PRDA Series

### Cylindrical Spatter-Resistant Inductive Proximity Sensors with Long Sensing Distance



#### FEATURES

- Coated with teflon for high heat resistance (prevent malfunction from welding spatter)
- Long sensing distance and excellent noise immunity with specialized sensor IC
- Built-in surge protection circuit, reverse polarity protection circuit, and overcurrent protection circuits
- Durable and reliable alternative to spatter-resistant limit switches



PRDA(T) Series Cable Type

PRDACM(T) Series Connector Type

PRDAW(T) Series Cable Connector Type

## PS/PSN Series

### Rectangular Inductive Proximity Sensors with Various Sizes



#### FEATURES

- Excellent noise resistance with specialized sensor IC
- Long life cycle, reliable performance, economical, and easy-to-install
- Built-in surge protection circuit
- Built-in reverse polarity protection circuit (DC 3-wire types)
- Built-in overcurrent protection circuit (DC types)
- Operation indicator (red LED)
- IP67 protection structure (IEC standard)



PSN17

PSN25

PS50

## PFI Series

### Flat Type Inductive Proximity Sensors



#### FEATURES

- Flat design (10 mm height) allows easy installation in limited spaces
- Excellent noise resistance with specialized sensor IC (DC types)
- Built-in reverse polarity protection circuit, overcurrent protection circuit (DC types)
- Built-in surge protection circuit
- Operation indicator (red LED)
- Durable and reliable alternative to micro switches and limit switches
- IP67 protection structure (IEC standard)



## AS Series

### Rectangular Inductive Proximity Sensors with Long Sensing Distance



#### FEATURES

- Long sensing distance of 50 mm
- Excellent noise immunity with specialized sensor IC
- Built-in surge protection circuit, reverse polarity protection circuit, and overcurrent protection circuits
- Power supply: 12-48 VDC (operating voltage: 10-65 VDC)
- Simultaneous output (Normally Open + Normally Closed)
- Power indicator (green LED) and operation indicator (red LED)
- IP67 protection structure (IEC standard)



## CR Series

### Cylindrical Capacitive Proximity Sensors

#### FEATURES

- Detect various materials including metal, iron, stone, plastic, water, and grain
- Long life cycle and reliable performance
- Built-in surge protection circuit, reverse polarity protection circuit (DC types)
- Built-in surge protection circuit (AC types)
- Built-in sensitivity adjuster for easier configuration

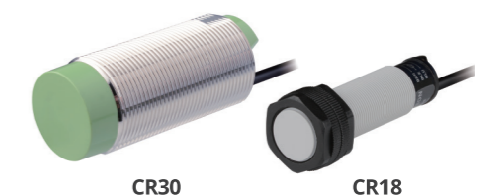

CR30

CR18

# MGA50S/MGAM50S Series

Shaft-Type Ø50 mm Magnetic Absolute Rotary Encoders

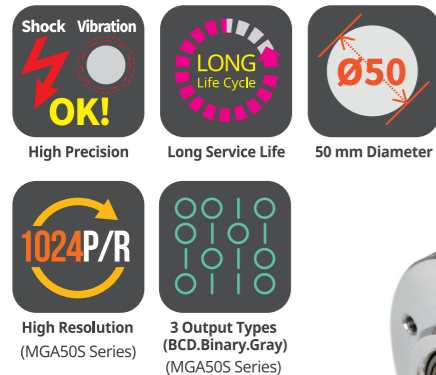

High precision under any condition

## FEATURES

### [Magnetic Encoders]

- High accuracy in harsh environments including shock, vibration, dust, and humidity (compared to optical sensors)
- Longer service life compared to optical encoders

### [MGA50S Series]

- Various output codes available: BCD, binary, Gray
- Various resolutions available: 32, 40, 45, 48, 64, 90, 128, 180, 256, 360, 512, 720, 1024 divisions
- Power supply: 5 VDC ±5%, 12-24 VDC ±5%
- IP50 protection structure (IEC standard)

### [MGAM50S Series]

- Output code: binary
- Control output types: Parallel / SSI
- 23-bit (8388608) total resolution
  - Single-turn: 10-bit (1024 divisions)
  - Multi-turn: 13-bit (8192 revolutions)
- IP50 protection structure (IEC standard)

## APPLICATION

- MGAM50S series magnetic absolute rotary encoders used to control the rotation angle of solar panels in relation to the position of the sun.

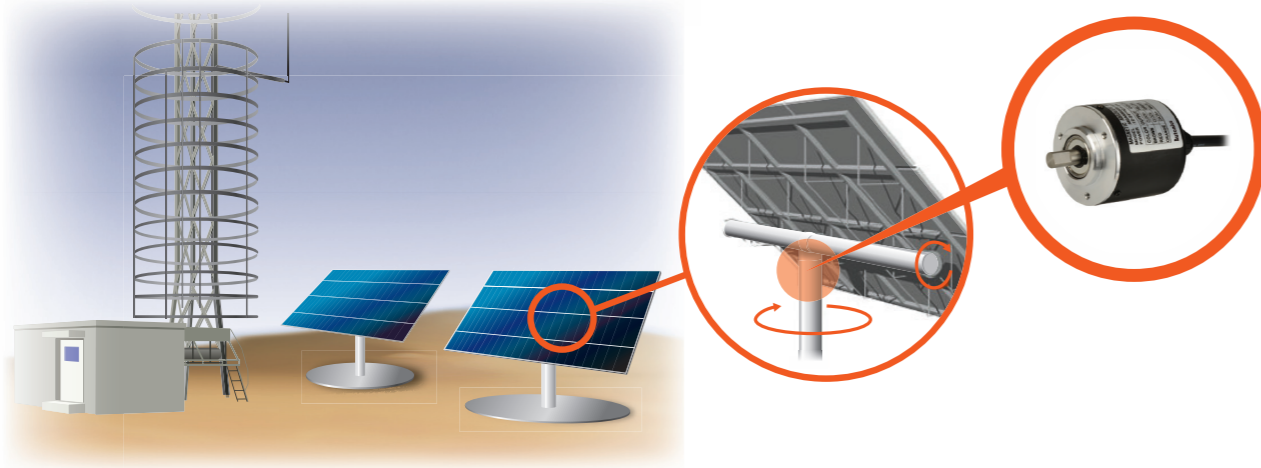

# E15S/E18S/E20S/E30S/E40S/E50S/E58S/E68S Series

Shaft Type Incremental Rotary Encoders



## FEATURES

- Encoder diameter: 15 mm, 18 mm, 20 mm, 30 mm, 40 mm, 50 mm, 58 mm, 68 mm
- Low shaft moment of inertia
- Various resolutions, output codes, control outputs, and cable types available



# E20HB/E40H/E58H/E60H/E80H/E100H Series

Hollow Shaft, Built-In Hollow Shaft Incremental Rotary Encoders



## FEATURES

- Encoder diameter: 20 mm, 40 mm, 58 mm, 60 mm, 80 mm, 100 mm
- Various hollow shaft sizes
- Various resolutions, output codes, control outputs, and cable types available

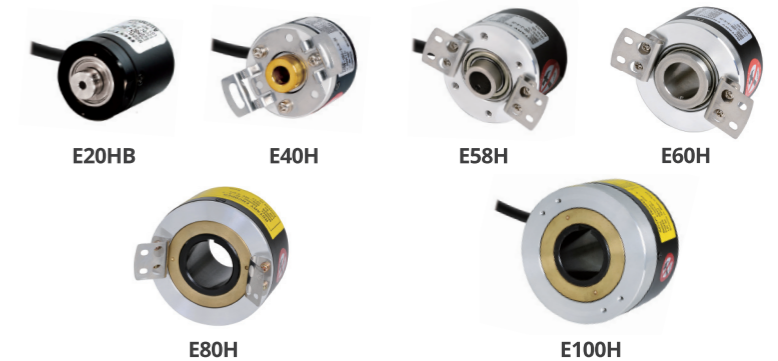

# EP50S Series

Shaft Type Ø50 mm Absolute Rotary Encoders



## FEATURES

- Compact size absolute rotary encoders with 50 mm diameter
- Various output codes available: BCD, binary, Gray
- Various resolutions, up to 1024 divisions: 6, 8, 10, 12, 16, 20, 24, 32, 40, 45, 48, 64, 90, 128, 180, 256, 360, 512, 720, 1024
- IP64 protection structure (IEC standard)



# EPM50 Series

Shaft Type Ø50 mm Multi-Turn Absolute Rotary Encoders



## FEATURES

- Control output types: Parallel / SSI
- 23-bit (8388608) total resolution
  - Single-turn: 10-bit (1024 divisions)
  - Multi-turn: 13-bit (8192 revolutions)
- Zero-point reset with single-turn data reset and multi-turn count reset functions
- CW/CCW direction setting function
- Overflow alarm (OVF) function

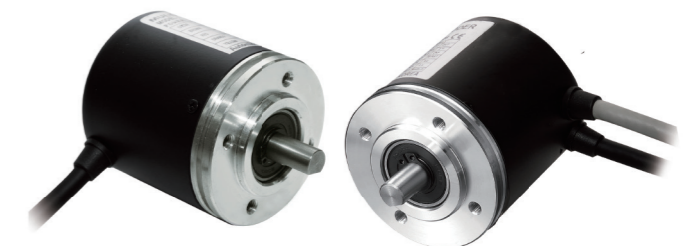

# TK Series

Standard High Accuracy PID Temperature Controllers



**50ms**  
High Speed Sampling

**HEAT COOL**  
Simultaneous Heating & Cooling Control

CURRENT  
 SSR  
Output Selection

**SSRP**  
SSRP Output (Standard/Phase/Cycle control selectable)

**EASY**  
Parameter Configuration

**RS485**  
RS485 Communication (Modbus RTU)

**DAQ Master**  
PC Monitoring

High-speed sampling, RS485 communication, and simultaneous heating/cooling control



## FEATURES

- 50 ms high-speed sampling rate and  $\pm 0.3\%$  display accuracy
- Simultaneous heating and cooling control function
- Automatic/manual control option
- Switch between current output and SSR drive output
- SSR drive output (SSRP function) control options: ON/OFF control, cycle control, phase control
- Communication output models available: RS485 (Modbus RTU)
- Parameter configuration via PC (DAQ Master)
- User-friendly parameter features
- **Low voltage (24 VAC, 24-48 VDC) models available (except TK4N models)**



TK4N  
(W) 48 mm x (H) 24 mm

## SYSTEM CONFIGURATION

- Temperature control for automobile parts injection molding

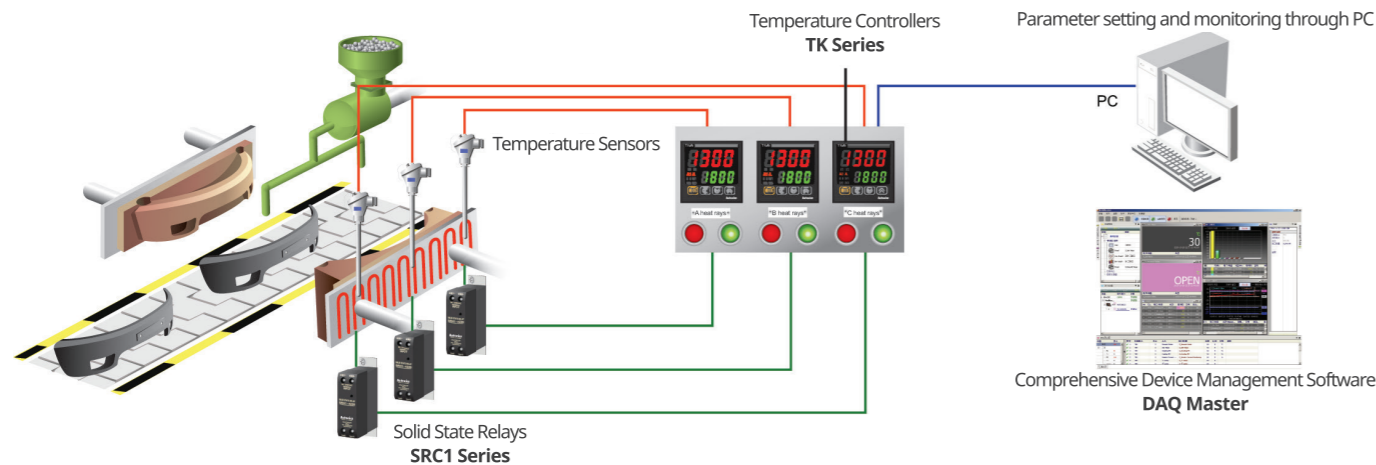

# TX Series

LCD Display PID Temperature Controllers



**1234**  
White Character LCD

**50ms**  
High Speed Sampling

11-Segment Display

**Relay-SSR**  
Current-Alarm  
Communication  
Various Output Options

**45mm**  
Size Reduction (30%)

CURRENT  
 SSR  
Output Selection

**SSRP**  
SSRP Output (Standard/Phase/Cycle control selectable)

11-Segment LCD display with easy-to-read, large 15.3 mm white PV characters



## FEATURES

- Large LCD display with easy-to-read white PV characters
- 50 ms high-speed sampling rate and  $\pm 0.3\%$  display accuracy
- Switch between current output and SSR drive output
- SSR drive output (SSRP function) control options: ON/OFF control, cycle control, phase control
- Communication output model available: RS485 (Modbus RTU)
- Parameter configuration via PC (DAQ Master)
- 11-segment display for improved display of alphanumeric characters
- Compact, space-saving design with 45 mm depth

## APPLICATION

- TX series temperature controllers used for accurate temperature control of commercial coffee roasters





# TM Series

## Modular Multi-Channel PID Temperature Controllers



### FEATURES

- Multi-channel (4-channel: TM4 / 2-channel: TM2) input and output control
- High-speed sampling cycle (4-channel: 100 ms / 2-channel: 50 ms)
- Module connection and expansion with expansion connectors
  - Communication between modules
  - No additional power supply wiring
  - Expandable up to 31 units (124-channels / 62-channels)
- Simultaneous heating and cooling control function
- Isolated input channels (dielectric strength: 1000 VAC)
- Parameter configuration via PC (USB and RS485 communication)
- Easy wiring and maintenance with various connectors: sensor input connector, control output connector, power/communication connector



### APPLICATION

- TM series multi-channel temperature controllers used for independent temperature control of sealing and cutting processes in stick packaging machines with multiple channel support



# TCN/TC Series

## Economical Dual/Single-Display PID Temperature Controllers



### FEATURES

- Dual display (TCN) and single display (TC) PID temperature controllers
- 100 ms high-speed sampling rate and  $\pm 0.5\%$  display accuracy
- Switch between relay output and SSR drive output
- SSR drive output (SSRP function) control options: ON/OFF control, cycle control, phase control
- Compact design with large display panels for easier reading
- Connector plug types offer easier wiring and maintenance (TCN4S-□-P)



# TA Series

## Analog Non-Indicating Type PID Temperature Controllers



### FEATURES

- Auto-tuning PID temperature control
- PID and ON/OFF control: toggle via external switch
- Deviation indicators (green, red LED)
- Control output indicator (red LED)
- Stop control output function using analog dial
- Sensor disconnect display function



# TF3 Series

## Refrigeration Temperature Controllers



### FEATURES

- Standard installation size for refrigeration panels (W 70.3 x H 28.2 mm)
- Various compressor load current capacity: 5A, 16A, 20A
- Various user-friendly functions:
  - Defrost sync function: simultaneous defrost operation of multiple controllers (up to 6 units)
  - RTC (Real Time Clock) function: night mode operation and real-time defrost control
  - Built-in alarm function
- Remote monitoring of real-time temperature and output control (using TFD series remote display unit, sold separately)
- Communication output models available: RS485 (Modbus RTU)
- Parameter configuration via PC (RS485 communication)
  - DAQMaster software included (comprehensive device management software)



Remote Display Unit  
TFD Series (sold separately)

### APPLICATION

- T3 series refrigeration temperature controllers used to control temperature of refrigerators inside food storage warehouses. TFD series display units used to check temperature and status from outside the warehouses.



# TC3YF Series

## Refrigeration Temperature Controllers



(Except 12-24VDC models)

### FEATURES

- ON/OFF control
- Standard input type: thermistor (NTC)
  - RTD (Pt100 $\Omega$ ) input models available upon request
- Temperature range:
  - Thermistor (NTC): -40.0 to 99.9  $^{\circ}\text{C}$  (-40 to 212  $^{\circ}\text{F}$ )
  - RTD (Pt100 $\Omega$ ): -99.9 to 99.9  $^{\circ}\text{C}$  (-148 to 212  $^{\circ}\text{F}$ )
- Various functions: auto/manual defrost selection, compressor start-up delay, restart delay, minimum ON time, end-defrost delay, evaporator fan operation delay



# SCM-WF48

## Wireless Communication Converters



### FEATURES

- Convert RS485/USB signals to Wi-Fi signals for wireless transmission up to 100 m
- Compact size (W 45 x H 25 x L 76.3 mm, without antenna)
- Built-in surge protection circuit and reverse polarity protection circuits
- Supports Access Point (AP) mode and Station (STA) modes
- Various mounting methods (DIN rail, screw mount)



# CT Series

Programmable Digital Counter/Timers

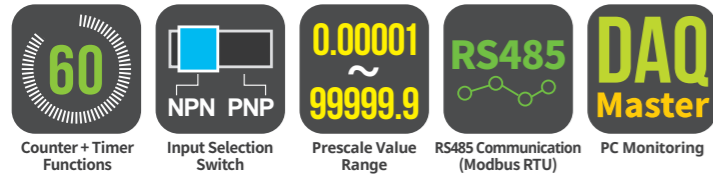

## FEATURES

- Integrated counter/timer unit for counting and timing requirements
- RS485 (Modbus RTU) communication (models available)
- One-shot output time: 0.01 s to 99.99 s

### [Counter Functions]

- Various input/output modes (9 input modes, 11 output modes)
- Prescale value range: 6-digit models: 0.00001 to 99999.9  
4-digit models: 0.001 to 999.9
- Batch counting function, set count starting point (value) function
- High-speed counting up to 10 kcps

### [Timer Functions]

- Various output modes (11 output modes)
- Time setting range: 6-digit models: 0.001 s to 99999.9 h  
4-digit models: 0.001 s to 9999 h

## APPLICATION

- Remote production quantity data management using communication function

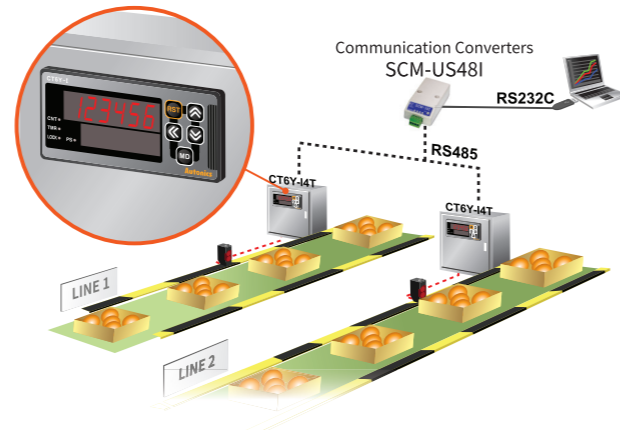

# LA8N / LE8N Series

Compact 8-Digit LCD Backlight Counters / Timers



## FEATURES

- Compact digital counters and timers with LCD backlight
- Count-up/down counters with decimal point setting (LA8N)
- Various time specification settings (LE8N)
- Voltage, no-voltage, universal voltage input options
- Built-in lithium battery (operates without external power)
- IP66 protection structure (IEC standard)



# LE365S-41

Compact Week/Year Digital Timers



## FEATURES

- Time configuration and control in week or year units
- Weekly day change operation, yearly holiday operation, season switching operation, auto daylight saving time function, etc.
- Independent control output (relay) built-in



# LE4S Series

Digital LCD Backlight Timers



## FEATURES

- Compact, space-saving design with LCD backlight
- Configure set value and time range independently (using flicker or ON-OFF delay output mode)
- One-shot output time: 0.01 s to 99.99 s
- Time setting range: 0.01 s to 9999 h
- Signal ON start and Power ON start options



# ATM Series

Miniature Analog Timers



## FEATURES

- Ultra-compact/miniature size (W 21.5 mm x H 28 mm x D 59.3 mm)
- Up to 4 simultaneous control outputs with 4PDT (250 VAC, 3 A)
- Simple and accurate timing control with analog dial
- Various timing ranges: 0.1 s to 3 h (11 available options, by model)
- Power supply: ATM4-2: 24 VDC  
ATM4-5: 220 VAC 50/60 Hz  
ATM4-6: 110 VAC 50/60 Hz

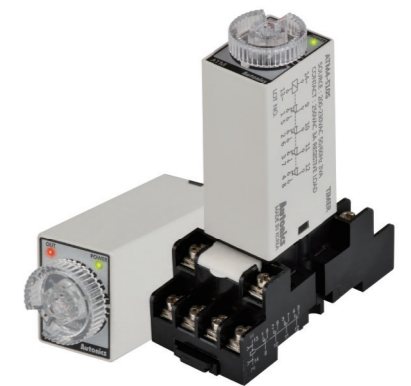

# ATS Series

Compact, Multi-Functional Analog Timers



## FEATURES

- Simple operation analog timers with various configurations
- Various time setting range and output operation modes
- Time setting range: 0.1 s to 30 h
- Twin timer models (ATS8W/ATS11W)
- Power ON start, Signal ON start, Power OFF start options



# SR(H)2/3 Series

Three-Phase Solid State Relays (2-Pole/3-Pole)



- Two Mounting Hole Types
- Alarm Output Function
- 24VAC Low Voltage Input
- 4,000VAC Dielectric Strength (Select Models)
- Removable Heatsink (Integrated Heatsink Types)
- Various Mounting Methods



Detachable Heatsink Type SR2/3 Series

Integrated Heatsink Type SRH2/3 Series

## FEATURES

- Two mounting hole types and sizes
- Alarm function (overheating)
  - Alarm output indicator (red LED), disconnect standard output, alarm output
- High dielectric strength: 4000 VAC (select models)
- Rated input voltage: 4-30 VDC, 24 VAC, 90-240 VAC
- Rated load voltage: 24-240 VAC, 48-480 VAC
- Rated load current: 15 A, 30 A, 40 A, 50 A, 75 A
- High heat dissipation efficiency with ceramic PCB and integrated heatsink
- Zero cross turn-on and random turn-on models available
- Input indicator (green LED)
- Various mounting methods (DIN rail, panel) – SRH2/SRH3 series
  - ※DIN rail mounting not available for 50 A and 70 A load current models

## APPLICATION

- Solid state relays used for temperature control of SMT machinery

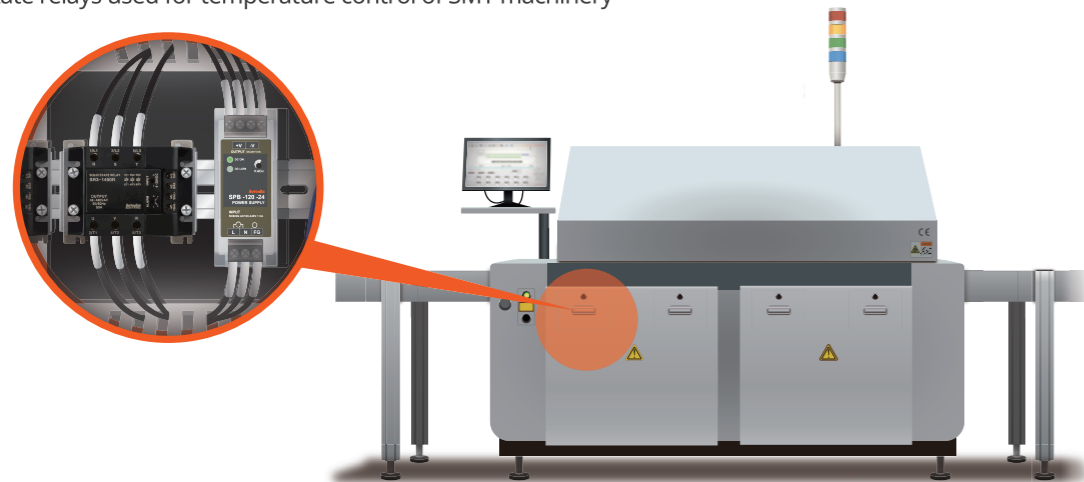



# SR1/SRH1/SRC1/SRS1/SRPH1 Series

Single Phase Solid State Relays



## FEATURES

- |  |  |   |
|--|--|---|
| <p><b>SR1 Series</b><br/>Detachable Heatsink Type</p>  <ul style="list-style-type: none"> <li>• Compact, universal design for flexible installation</li> <li>• Rated input voltage: 4-30 VDC, 90-240 VAC</li> <li>• Rated load voltage: 24-240 VAC, 48-480 VAC</li> <li>• Rated load current (resistive load) : 15 A, 25 A, 40 A, 50 A, 75 A</li> </ul> | <p><b>SRH1 Series</b><br/>Integrated Heatsink Type</p>  <ul style="list-style-type: none"> <li>• DIN rail mount or panel mount installation</li> <li>• Rated input voltage: 4-30 VDC, 90-240 VAC, 24 VAC</li> <li>• Rated load voltage: 24-240 VAC, 48-480 VAC</li> <li>• Rated load current (resistive load) : 15 A, 25 A, 30 A, 40 A, 60 A</li> </ul> | <p><b>SRC1 Series</b><br/>Slim Detachable Heatsink Type</p>  <ul style="list-style-type: none"> <li>• Slim, compact size (22.5 mm width)</li> <li>• Rated input voltage: 4-30 VDC, 90-240 VAC</li> <li>• Rated load voltage: 24-240 VAC, 48-480 VAC</li> <li>• Rated load current (resistive load) : 15 A, 25 A, 30 A</li> </ul> |
|--|--|---|

## SRS1 Series Socket Type



- Socket type for easier installation and maintenance
  - SRS1-A: Autonics SK-G05 sockets (AC, DC, AC/DC)
  - SRS1-B: Universal LY2 sockets (AC)
- Rated input voltage: 4-24 VDC (SRS1-A), 4-30 VDC (SRS1-B)
- Rated load voltage:
  - SRS1-A: 24-240 VAC, 5-100 VDC, 5-200 VDC, 5-240 VAC/5-200 VDC (AC/DC type)
  - SRS1-B: 90-240 VAC
- Rated load current (resistive load): 1 A, 2 A, 3 A, 5 A

## SRPH1 Series Analog Input Type



- Phase control and cycle control with 4-20 mA analog input
  - Phase control (output power control / phase angle control)
  - Cycle control (fixed cycle / variable cycle)
- Rated input voltage: 4-20 mA (analog input)
  - Rated load voltage: 100-240 VAC, 200-480 VAC
  - Rated load current (resistive load): 20 A, 30 A, 60 A

## FEATURES

- Common Features**
- Slim and compact design
  - High dielectric strength: 4000 VAC (except SRS1)
  - High heat dissipation efficiency with ceramic PCB
  - LED status indicators

## APPLICATION

- Solid state relays used in conjunction with temperature controllers during package sealing process in food packaging machines.



# SPB Series

High Efficiency Switching Mode Power Supplies



## FEATURES

- DIN rail mount and screw mount methods
- Efficient power conversion
  - High conversion efficiency up to 92% with LLC circuit (SPB-240)
  - Stable power supply with minimal noise and ripple
- Space efficient design
  - Slim and compact size for maximum space efficiency
  - Uniform depth size (except SPB-015/030) for neat and tidy installation
- Safety and user-friendly features
  - Terminal protection cover (SPB-060/120/180/240)
  - Easy wiring with rising clamp terminal (SPB-015/030)
  - Inrush current prevention, output overcurrent prevention, output overvoltage prevention, output short-circuit protection, circuit overheating protection
  - Low output voltage indicator (red LED), output indicator (green LED)
- Output power: 15W, 30W, 60W, 120W, 240W



# DS/DA Series

Intelligent Type Digital Display Units

Display Units



## FEATURES

- Simple wiring without soldering
  - Multi-stage connection using expansion connectors or ribbon cables
  - Power supply and data wiring required on base unit only
- Various input options:
  - Serial input, Parallel input, RS485 communication input, RS485 communication time sync display, PT temperature sensor input, PT temperature sensor + RS485 communication input
- Expandable up to 24 units with multi-stage connection
- Available in various sizes: 16 mm, 22.5 mm, 40 mm, 60 mm
- Available in 7-segment display and 16-segment display types
- Available in red display and green display types



# ARM / ARD Series

Modbus RTU & DeviceNet Digital Remote I/O

Field Network Devices



## FEATURES

- [ARM Series]**
- Modbus RTU protocol digital remote I/O
  - Additional expansion
    - Expand up to 63 base units per master unit
    - Expand up to 7 expansion units per base unit (up to 64 points)
- [ARD Series]**
- DeviceNet protocol digital/analog remote I/O
  - Additional expansion
    - Standard terminal block type: connect up to 3 expansion units
    - Sensor connector type: connect up to 7 expansion units
    - I/O points can be expanded up to 64 points

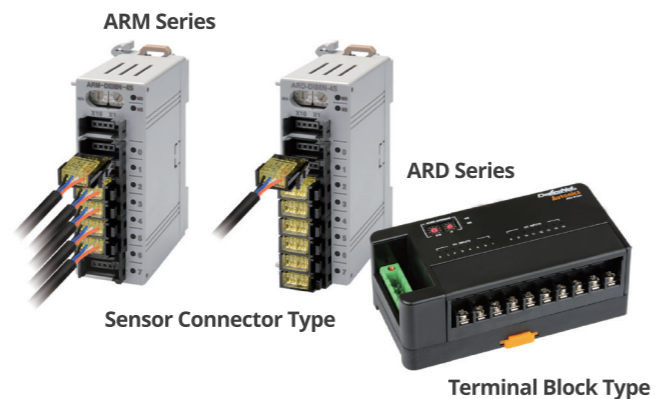

# LP-S070 / GP-S070 Series

7-Inch LCD Color Display Logic / Graphic Panels



## FEATURES

- All-in-one device featuring HMI + PLC + I/O module (LP-S070)
- Graphic HMI with simple operation and configuration (GP-S070)
- 7-inch widescreen analog resistive LCD touchscreen
- Data logger function: store and backup data from control devices
- Connection interfaces: RS232C/RS422/Ethernet/USB
- Software update and support via Autonics website



LP-S070 Series

GP-S070 Series

## APPLICATION

- Logic panels used with counters to monitor quantity and barcode recognition of packaged boxes during shipping process



# MT4 Series

Digital Panel Meters

Panel Meters



## FEATURES

- Various input/output options (default option: indicator/no output)
  - Input: DC voltage, DC current, AC voltage, AC current
  - Output: RS485 communication output, PV transmission output (DC 4-20 mA), NPN/PNP open collector output, relay contact output
- Maximum allowed input: 50 VDC, DC 500 mA, 250 VAC, AC 5 A (MT4N) 5 VDC, DC 500 mA, 500 VAC, AC 5 A (MT4W/Y)
- Display range: -1999 to 9999
- AC frequency measurement (range: 0.1 to 9999 Hz)



MT4N Series

# M4NN Series

Compact Digital Panel Meters



## FEATURES

- Various input options: DC voltage, DC current, AC voltage, AC current
- Isolated input and power modules allow powering of multiple units using a single power supply
- Display range: -1999 to 9999
- AC frequency measurement (range: 0.1 to 9999 Hz)
- Various functions: high/low-limit display scale, power factor display, peak display value monitoring, display cycle delay, zero-point adjustment, peak display value correction



(W) 48 mm × (H) 24 mm × (L) 46 mm

# AiS Series

## 2-Phase Closed Loop Stepper Motor System

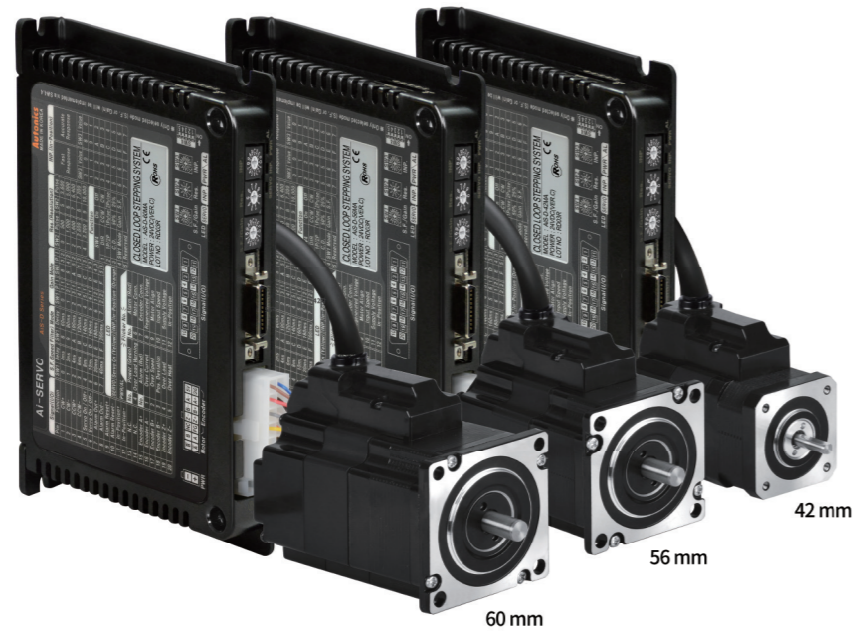
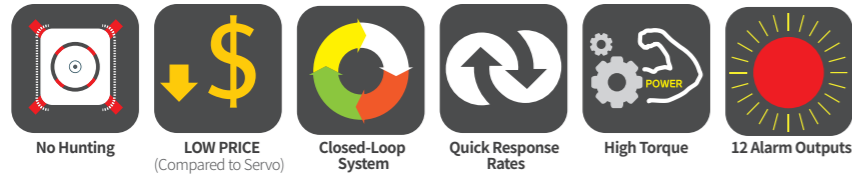

### FEATURES

- Low cost closed loop system compared to servo motors with quick response rates for better continuous drive operation
- Low vibration during low speed drive and high torque during high speed drive
- No tuning required (easy gain setting using adjuster)
- Holding torque and no vibration (hunting) during position hold make it ideal for precision machines including optical inspection
- Various encoder resolutions: 500, 1000, 1600, 2000, 3200, 3600, 5000, 6400, 7200, 10000 (10-stages)
- Various alarm outputs: overcurrent, overspeed, overheating, motor connection error, encoder connection error, etc. (12 alarms)
- Frame sizes: 42 mm, 56 mm, 60 mm

※ Applications: semiconductor equipment, 3D printers, optical inspection machines, SMT machines, cartesian robots, conveying equipment, alignment stages, and other precision machines.

### APPLICATION

- AiS series closed loop stepper motor system used for vertical axis control of vision equipment on 3D inspection machinery.



# AK(B)/AHK/AK-G(B)/AK-R(B) Series

## 5-Phase Stepper Motors



### FEATURES

- Compact design and lightweight with high accuracy, speed, and torque
- Space-saving design ideal for building compact-sized systems
- Various types: shaft, hollow shaft, brake, geared, geared-brake, rotary actuator, rotary actuator-brake type
- Various frame sizes: 24, 42, 60, 85 mm
- Economical and cost-efficient

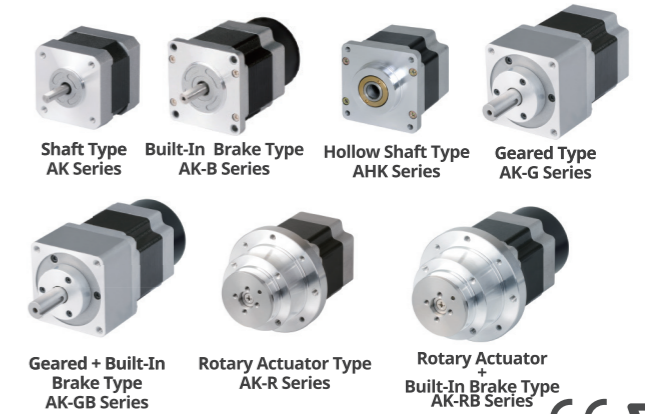

# MD5 Series

## 5-Phase Stepper Motor Drivers

### FEATURES

- Bipolar constant current pentagon drive type
- Auto-current down and self-diagnosis function
- Microstepping drive (max 250 divisions)
- Isolated photocoupler input design minimizes influence from external noise
- Multi-axis control (MD5-HD14-2X/3X)



# PMC-2HSP/N Series

## 2-Axis Programmable Motion Controllers



### FEATURES

- High-speed independent 2-axis control with processing speed up to 4 Mpps
- 17 control commands and up to 200 steps of operation programming
- Multiple control of up to 32-axes (16 units) with RS485 communication
- 4 operation modes: scan, continuous, index, program
- Connection interfaces: RS232C/RS485/USB/Parallel I/O

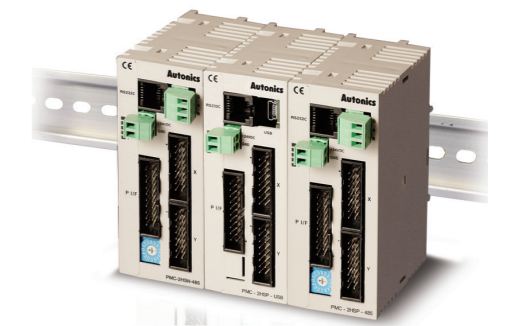

### SYSTEM CONFIGURATION

- Multi-axis control via RS485 communication

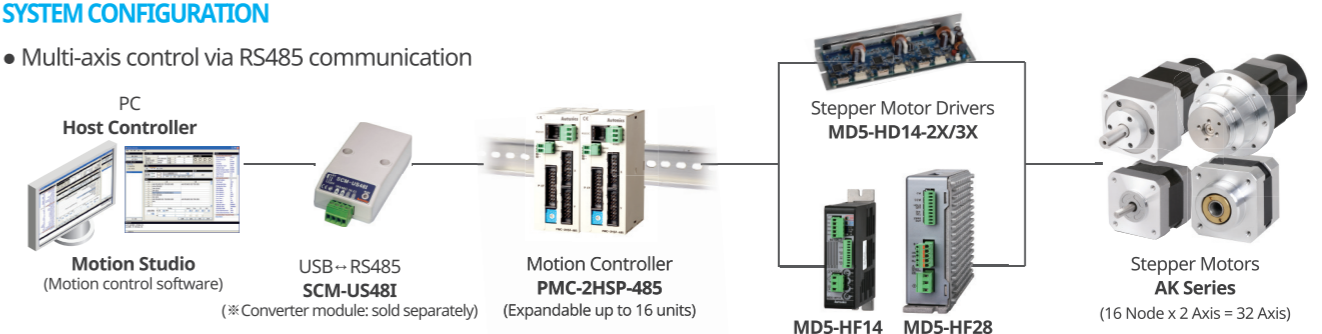

# I/O Terminal Blocks

Highly Durable and Compatible I/O Terminal Blocks



## Interface Type

**AFL Series**  
One-Push Screwless Type



**AFR Series**  
Rising Clamp Type

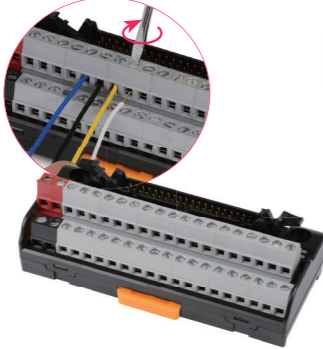

**AFS Series**  
Standard Type



**Common Type**  
**ACS Series**



**Sensor Connector Type**  
**AFE Series**



**Relay Type**  
**ABS Series**  
Standard Type



**ABL Series**  
Screwless Type



**ASL Series**  
SSR Type



## SYSTEM CONFIGURATION

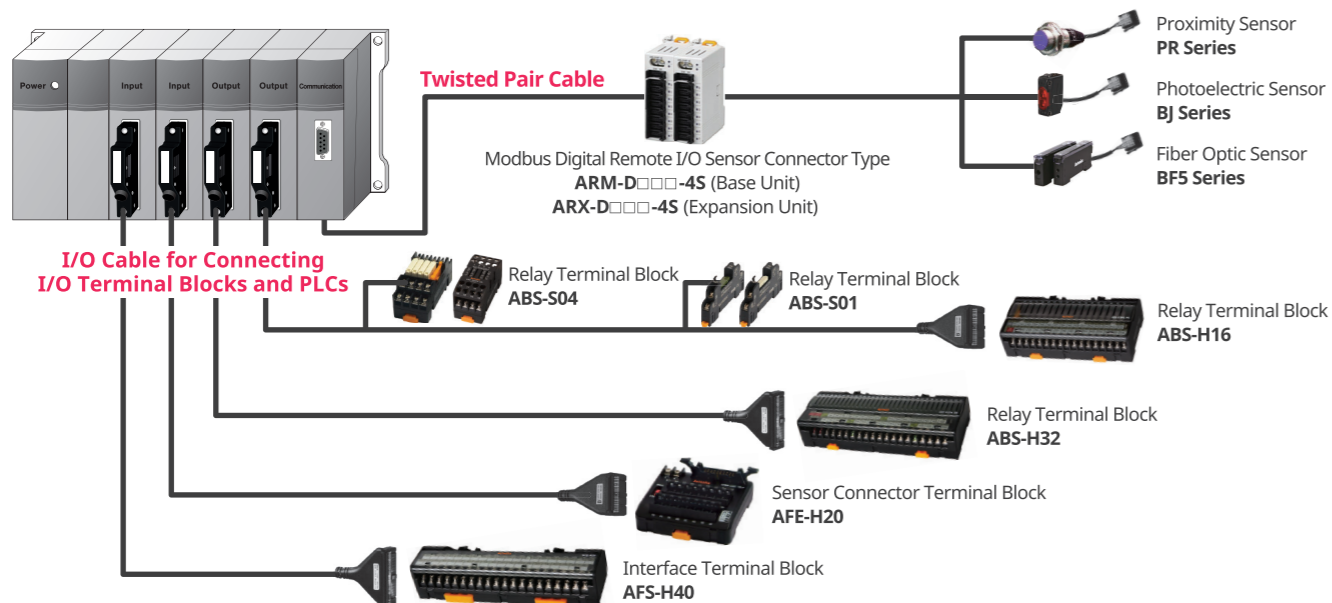

# CJ Series

Connector Cables

## FEATURES

- Compatible with various PLCs and control devices (Autonics, LSIS, Mitsubishi, etc.)
- Available in various lengths (0.5 m, 1.0 m, 1.5 m, 2.0 m, custom)
- Various pin sizes (20-pin, 37-pin, 40-pin, 50-pin)
- Diverse options and configurations to fit user requirements



# PT Series

M12 Connector Sensor Distribution Boxes

## FEATURES

- Available models:
  - 5-pin M12 connector types (cable/connector/spring terminal/plug-in terminal)
  - 4-pin M12 connector type (cable)
- Supply power to multiple sensors using a single power supply
- Simplify complicated wiring and maintenance work
- Check operation status with LED indicators (green, red LED)
- Supports 1-signal, 2-signal (DC 4-wire type)



PT-P (plug-in terminal type), PT-S (spring terminal type) series available in black and blue models.

# CNE Series

Sensor Connectors

## FEATURES

- **Common Features**
  - Significantly reduce installation work and time
  - Features high density mounting and contact pitch of 2 mm
  - Compatible with e-CON connectors
  - Each pin can hold up to 3A of current
- **Wire Mount Plug/Socket**
  - Compact and reliable one-touch type sensor connector
  - Wire mount plug / socket enables transit connection of wires
  - Visual guide on wire thicknesses with colorful covers
  - Visual guide on status of wire connection through translucent cover
- **Board Mount Socket**
  - Position contact point in mold to avoid electric shock or short-circuit

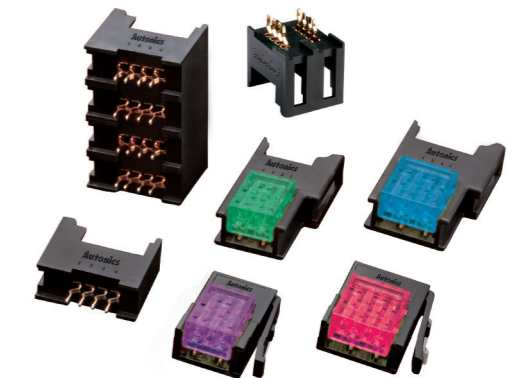

## SYSTEM CONFIGURATION

• Sensors ↔ Expansion Cable ↔ PCB

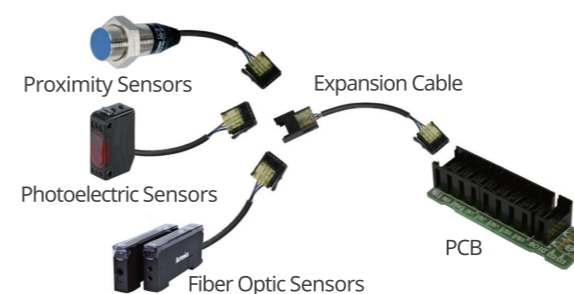

• Sensors ↔ PLC

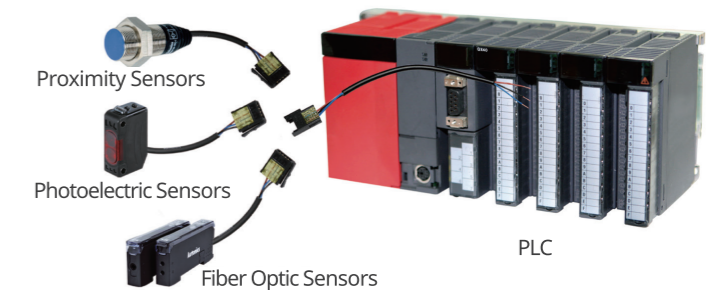

# KRN1000 Series

LCD Touchscreen Paperless Recorders

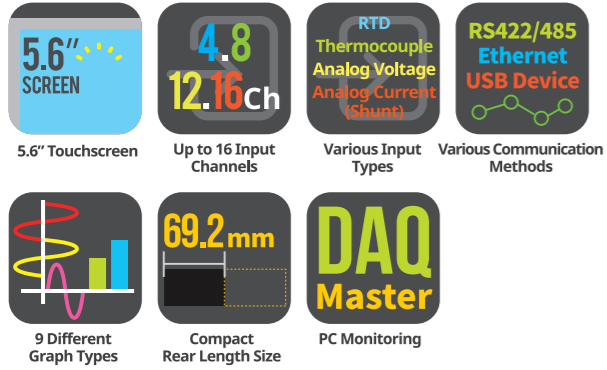

## FEATURES

- 5.6-inch TFT color LCD (640x480) touchscreen display with excellent visibility and intuitive control interface
- Supports 27 input types (thermocouple, RTD, analog voltage and current[shunt])
- 4 / 8 / 12 / 16 input channel models available
- Various communication methods (USB, RS422/485, Ethernet) supported
- 25 to 250 ms high-speed sampling, 1 to 3600 s recording cycle
- 200 MB internal memory and external memory support (SD/USB up to 32 GB)
- Store and backup internal data to external memory (SD/USB)
- 9 different graph types available
- Various option input/output available: digital input (contact/non-contact), alarm output, transmitter power output
- Compact, space-saving design (rear length: 69.2 mm)

## APPLICATION

- Record and store real-time measurement data in thermo-hygrostat systems



# KRN100 Series

100 mm Hybrid Recorders



## FEATURES

- Hybrid strip chart recorder + paperless recorder
- Data logger function: print saved data from internal memory or USB
- Status monitoring and parameter configuration through USB, RS485, or Ethernet
- 25 ms high-speed sampling, 240 mm/H high-speed recording
- 100 mm strip chart recording in 6 colors
- Supports up to 12 input channels and 27 input types



# KRN50 Series

50 mm Hybrid Recorders



## FEATURES

- 50 mm strip chart recorders with thermal transfer printing
- Data logger function for paperless recording
- Real-time monitoring and configuration on PC/PLC via RS485 communication or dedicated communication port
- Simultaneous 2-channel recording (graph mode, digital mode)
- Supports various input types (RTD, thermocouple, analog)



# TPS30 Series

Stainless Steel Pressure Transmitters



## FEATURES

- Robust build allows high or low pressure measurement in high and low temperature environments
  - : high pressure (0 to 60 MPa / 0 to 600 bar),
  - low pressure (0 to 2 MPa / 0 to 20 bar)
- temperature range (-40° to 125°C) (may vary by model)
- For diverse applications including packaging machines, heavy machinery, factories, and shipbuilding
- 316L stainless steel diaphragm for high corrosion resistance (except head component of head types)
- Analog output : current (DC 4-20 mA), voltage (1-5 VDC)
- Available thread sizes: G3/8, G1/4, R1/2
- IP67 protection structure (IEC standard) (DIN43650-A connector type: IP65)

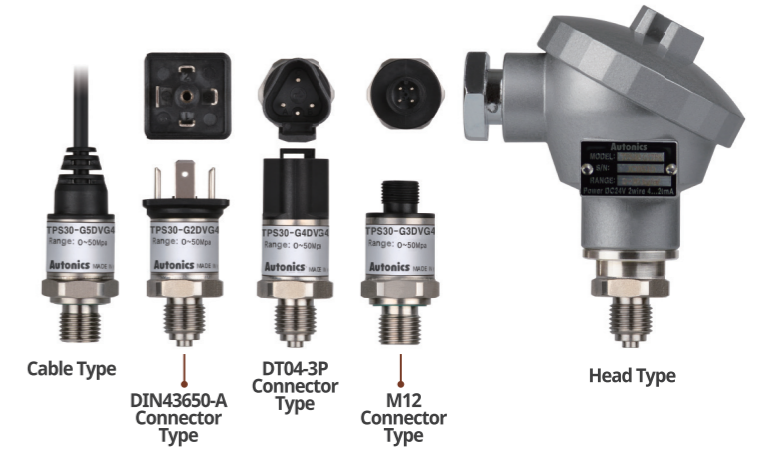

# KN-1000B Series

Compact Digital/Bar Graph Indicators



## FEATURES

- High accuracy with 16-bit ADC ( $\pm 0.2\%$  F.S.)
- Supports various input types (RTD, thermocouple, analog)
- Bar graph with 101 LEDs (green), 4-digit digital LED display (red)
- Various output options and customized functions
- Built-in power supply for sensors (24 VDC)



# KN-2000W Series

High Accuracy Multi-Color Indicators



## FEATURES

- High accuracy with 16-bit ADC ( $\pm 0.2\%$  F.S.)
- Supports various input types (RTD, thermocouple, analog)
- Auto display color change function (errors/alarms)
- Display range: -19999 to 19999
- Various output options and customized functions
- Built-in power supply for sensors (24 VDC)



## Process Automation Devices



**DPU/DPUS Series**  
Digital Thyristor Power Controllers



**CN-6000 Series**  
Isolated Converters with 3-Color Display



**KPN Series**  
High Accuracy Digital Process Controllers



**PTF30 Series**  
2-Wire Smart Pressure Transmitters



**KT-302H Series**  
Intelligent Type Pressure Transmitters



**KT-502H**  
Intelligent Type Temperature Transmitters

# S/L/B Series

Control Switches, Pilot Lights, and Buzzers (※) Illuminated Type Available



(UL - except emergency switches, buzzers)

## Round/Square Push Button Switches

### S16PR Series (Ø16)

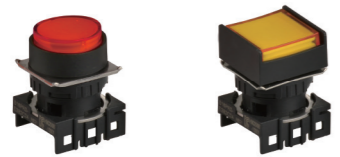

S16PR-E (※) S16PRS-H (※)

### S2PR Series (Ø22/25)



S2PR-P □ S2PR(U)-P □ (※)

### S3PR / S3PF / SQ3PFS Series (Ø30, □30)



S3PR-P □ S3PF(U)-P □ (※)



S16PRT-H (※)



S2PR(U)-E (※) S2PRS(U)-P (※)



SQ3PFS(U)-P (※)

## Pilot Lights

### L16RR Series (Ø16)

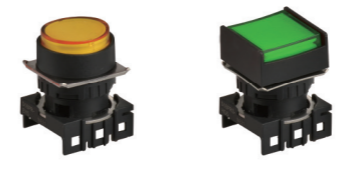

L16RR-E (※) L16RRS-H (※)

### L2RR Series (Ø22/25)



L2RR-L1 (※) L2RR-L2 (※)

### L3RF Series (Ø30, □30)



L3RF(U)-L3 (※) LQ3RF(U)-L4 (※)



L16RRT-H (※)



L2RR(U)-L3 (※)



L2RR(U)-L4 (※)

## Selector Switches

### S16SR Series (Ø16)



S16SR-S (※) S16SRS-L (※)

### S2SR Series (Ø22/25)



S2SR-S1/3/5/7/A/C □ S2SRN-□1/3/5/7/A/C (※)

### S3SF Series (Ø30)



S3SF-S1/3/5/7/A/C □ S3SFN-□1/3/5/7/A/C (※)



S16SRT-S (※)



S2SR-S2/4/6/8/B/D □ S2SRN-□2/4/6/8/B/D (※)



S3SF-S2/4/6/8/B/D □ S3SFN-□2/4/6/8/B/D (※)

## Key Selector Switches

### S16KR / S2KR / S3KF Series (Ø16, Ø22/25, Ø30)



S16KR S16KRS S16KRT



S2KR



S3KF

## Mushroom-Head Push Button Switches

### S16BR / S2BR Series (Ø16, Ø22/25)



S16BR-H (※)



S2BR-P1 □

## Double Push Button Switches

### S2TR Series (Ø22/25)



S2TR-P3 (※)

## Emergency Switches

### S16ER Series (Ø16)



S16ER-E □

### S2ER Series (Ø22/25)



S2ER-E1 □



S2ER-E2 □



S2ER-E3 □



S2ER-E4 (※) □



S2ER-E5 □

## Buzzers

### B6MA Series



Melody Buzzer

### B2PB-B1D



Piezo Buzzer

### B2NB-B1D Series



Magnetic Buzzer

## Accessories

※ Only for Ø16



Switch Contact Blocks

※ Only for Ø22/25, Ø30, □30

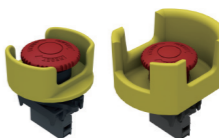

Emergency Switch Protective Shrouds



Emergency Switch Nameplates



Waterproof Cap



Switch Enclosures



※ Only for Ø16

Locking Handle for Switches

※ Only for Ø22/25, Ø30, □30



※ Only for Ø16

Lens removal tool



# Driving towards global leadership in the automation industry

Autonics, a leading expert of the industrial automation industry in South Korea, provides efficient and productive automation solutions to customers across the globe.  
Our mission is to enrich the quality of human lives by delivering new values that will make the world more convenient.



## • Major Products

• Photoelectric Sensors · Fiber Optic Sensors · Door Sensors · Door Side Sensors · Area Sensors  
 • Proximity Sensors · Pressure Sensors · Connectors / Sockets · Rotary Encoders · Panel Meters  
 • Counters · Timers · Temperature Controllers · SSR / Power Controllers · Sensor Controllers  
 • Graphic / Logic Panels · Temperature / Humidity Transducers · Switching Mode Power Supplies  
 • Stepper Motors / Drivers / Motion Controllers · I/O Terminal Blocks & Cables · Display Units  
 • Control Switches / Lamps / Buzzers · Field Network Devices · Tachometer / Pulse (Rate) Meters  
 • Laser Marking System (Fiber, CO<sub>2</sub>, Nd:YAG) · Laser Welding / Cutting System

※ The dimensions or specifications on this selection guide may change and some models may be discontinued without notice.

- **Corporate Headquarters / Overseas Business Headquarters**  
 18 Bansong-ro, 513 Beon-gil, Haeundae-gu, Busan, South Korea 48002  
 Tel : 82-51-519-3232 / Fax : 82-51-519-3031 / E-mail : sales@autonics.com
- **Brazil - Autonics do Brasil Comercial Importadora Exportadora Ltda**  
 Tel: 55-11-2307-8480 / Fax: 55-11-2309-7784 / E-mail: comercial@autonics.com.br
- **China - Autonics electronic(Jiaying) Corporation**  
 Tel: 86-21-5422-5969 / Fax: 86-21-5422-5961 / E-mail: china@autonics.com
- **India - Autonics Automation India Private Limited**  
 Tel: 91-22-2768-2570 / E-mail: india@autonics.com
- **Indonesia - PT. Autonics Indonesia**  
 Tel: 62-21-8088-8814/5 / Fax: 62-21-8088-4442/0 / E-mail: indonesia@autonics.com
- **Iran - Autonics Corp. Iran Representative Office**  
 Tel: 98-21-8872-7251/2 / Fax: 98-21-8872-8556 / E-mail: iran@autonics.com
- **Japan - Autonics Japan Corporation**  
 Tel: 81-3-3950-3111 / Fax: 81-3-3950-3191 / E-mail: ja@autonics.com
- **Malaysia - Mal-Autonics Sensor Sdn. Bhd.**  
 Tel: 60-3-7805-7190 / Fax: 60-3-7805-7193 / E-mail: malaysia@autonics.com
- **Mexico - Autonics Mexico S.A. DE C.V**  
 Tel: 52-55-5207-0019 / Fax: 52-55-1663-0712 / E-mail: ventas@autonics.mx
- **Russia - Autonics Rus**  
 Tel/Fax: 7-495-660-10-88 / E-mail: russia@autonics.com
- **Turkey - Autonics Otomasyon Ticaret Ltd. Sti.**  
 Tel: 90-216-365-9117/3/4 / Fax: 90-216-365-9112 / E-mail: turkey@autonics.com
- **USA - Autonics USA, Inc.**  
 Tel: 1-847-680-8160 / Fax: 1-847-680-8155 / E-mail: sales@autonicsusa.net
- **Vietnam - Cong Ty Tnhh Autonics Vina**  
 Tel: 84-28-3771-2662 / Fax: 84-28-3771-2663 / E-mail: vietnam@autonics.com